

## INSTRUCTION MANUAL

## HTD-5201

### DVD Home Theater System

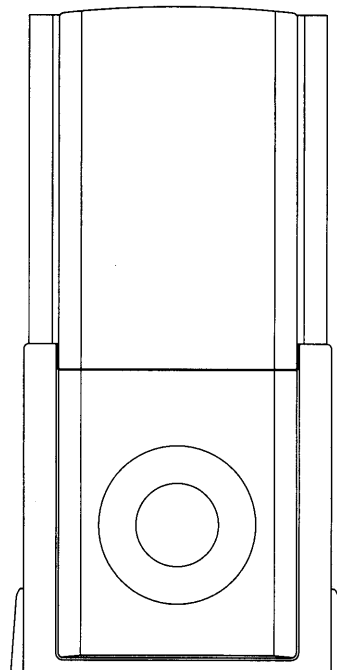
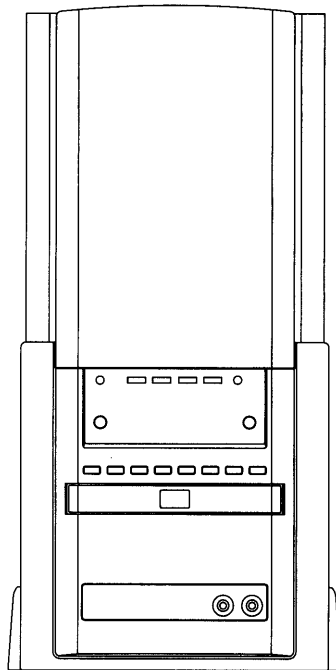
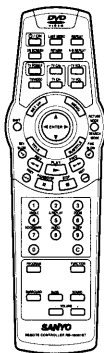

# PRECAUTIONS

## CAUTION

THIS PRODUCT CONTAINS A LOW POWER LASER DEVICE, TO ENSURE CONTINUED SAFETY DO NOT REMOVE ANY COVERS OR ATTEMPT TO GAIN ACCESS TO THE INSIDE OF THE PRODUCT.

REFER ALL SERVICING TO QUALIFIED PERSONNEL.

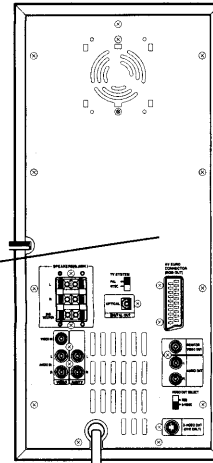
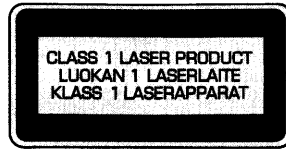

- The apparatus shall not be exposed to dripping or splashing.
- Do not use where there are extremes of temperature (below 5°C or exceeding 35°C) or where direct sunlight may strike it.
- Because of the DVD/CD player's extremely low noise and wide dynamic range, there might be a tendency to set the volume on the amplifier unnecessarily high. Doing so may produce an excessively large output from the amplifier which could damage your speakers.
- Sudden changes in the ambient temperature may cause condensation to form on the optical lens inside the unit. If this happens, take out the disc, leave the unit for about 1 hour, and then proceed to operate.
- When carrying the unit, be sure to remove a disc which may be inside and turn the power off. Wait at least 10 seconds, then unplug the mains lead from the AC outlet. Carrying the unit with a disc inside may damage the disc and/or the unit.
- Do not install this equipment in a confined space, such as a book case or built in cabinet.

### Important Information:

To connect this unit to a TV, TV must have a Video input socket or a Euro-AV socket. You cannot use an RF input socket or antenna terminal to connect this unit.

This product incorporates copyright protection technology that is protected by method claims of certain U.S. patents and other intellectual property rights owned by Macrovision Corporation and other rights owners. Use of this copyright protection technology must be authorized by Macrovision Corporation, and is intended for home and other limited viewing uses only unless otherwise authorized by Macrovision Corporation. Reverse engineering or disassembly is prohibited.

## IMPORTANT

If the plug supplied with this equipment is not suitable for the socket outlets in your home it should be cut off and replaced with the correct type.

### Disposal of Plug

If the non rewirable plug is to be cut off, the removed plug should be disposed of carefully as there is a shock hazard should the plug be inserted into a live socket.

### Replacing Fuse

The detachable fuse cover must be replaced after changing the fuse. Only a 3A fuse should be used and should comply with BS1362 and should carry the ASTA mark .

The wires in the mains lead are coloured in accordance with the following code;

Blue	Neutral
Brown	Live

The wires in the mains lead must be connected to the terminals in the plug as follows;

Wire colour	Plug terminal marking
Blue	N or Black or Blue
Brown	L or Red or Brown

Do not connect either wire to the earth terminal.

If the mains plug contains a fuse this should be 3A, if a plug without a fuse is used the distribution board fuse should not be greater than 5A.

The unit is not disconnected from the mains unless it is unplugged from the AC outlet.

# CONTROLS

**HTD-5201M: Main unit with main speaker**

**SX-5201: Main speaker with subwoofer**

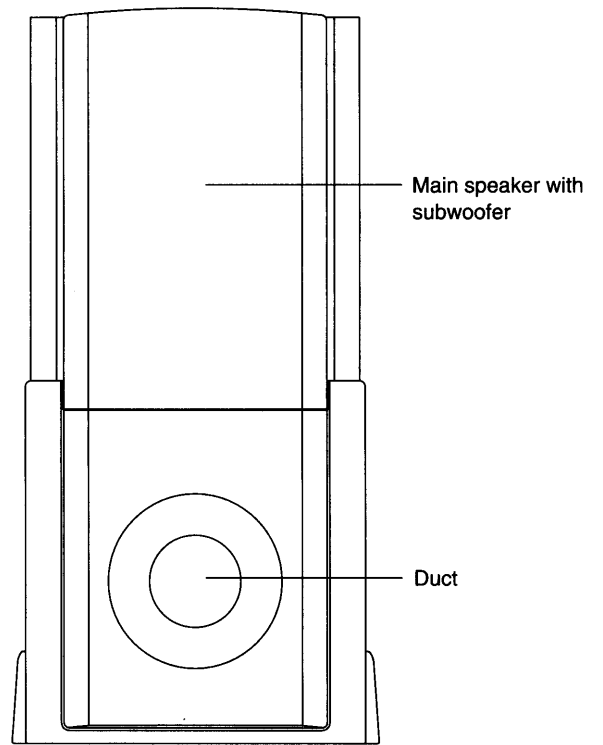
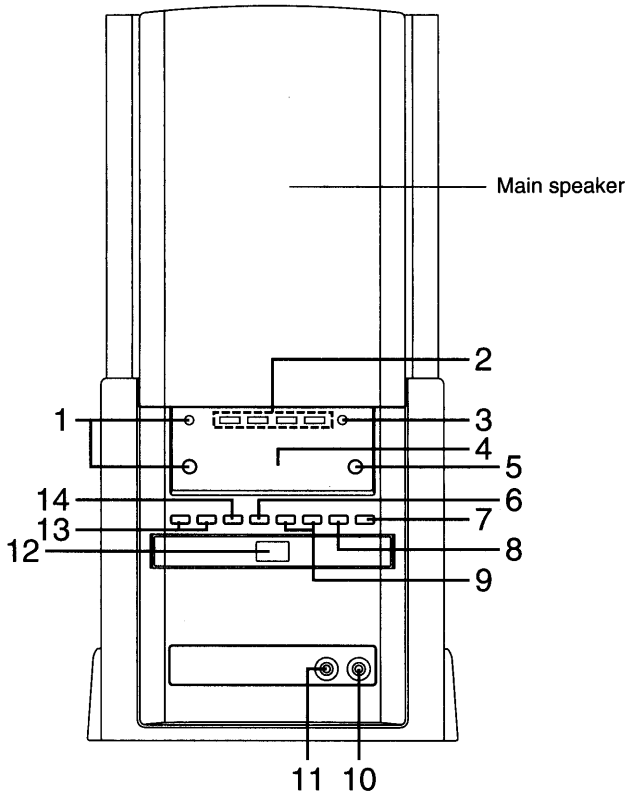

1. Power button/Standby indicator (⏻/ON, STANDBY)
2. Function indicators (DVD/CD, VIDEO, AUX/TV, M.MEDIA)
3. Remote sensor (IR)
4. Display
5. Disc tray open/close button (▲ OPEN/CLOSE)
6. Pause/Step button (⏸/STEP)
7. Play button (▶ PLAY)

8. Stop button (■ STOP)
9. Skip/Next/Previous buttons (⏮, ⏭)
10. Headphones socket (PHONES)
11. Multi media input socket (MULTI MEDIA IN)
12. Disc tray
13. Volume buttons (VOLUME)
14. Function button (FUNCTION)

# REMOTE CONTROL

**Note:**

In this instruction manual, any operation of pressing any button while pressing the SHIFT button is as shown below.

Example: "Press the **SHIFT + ANGLE** buttons."

**Controls**

1. Power button (ON/OFF)
2. TV control buttons  
Power button (TV POWER)  
TV/Video select button (TV/VIDEO)
3. Picture mode/Search mode button (PICTURE MODE/SEARCH MODE)
4. Number and other function buttons  
Number buttons (1 - 9, 0)  
Angle button (ANGLE)  
Angle replay button (A.REPLAY)  
Zoom button (ZOOM)  
Bookmark button (BOOKMARK)  
Audio button (AUDIO)  
Sleep button (SLEEP)
5. Clear button (C)
6. General control buttons  
Function button (FUNCTION)  
Surround button (SURROUND)  
Bass button (BASS)  
Sound button (SOUND)  
Volume buttons (VOLUME)
7. Shift button (SHIFT)
8. Last memory button (LAST MEMO)
9. Repeat button (REPEAT)

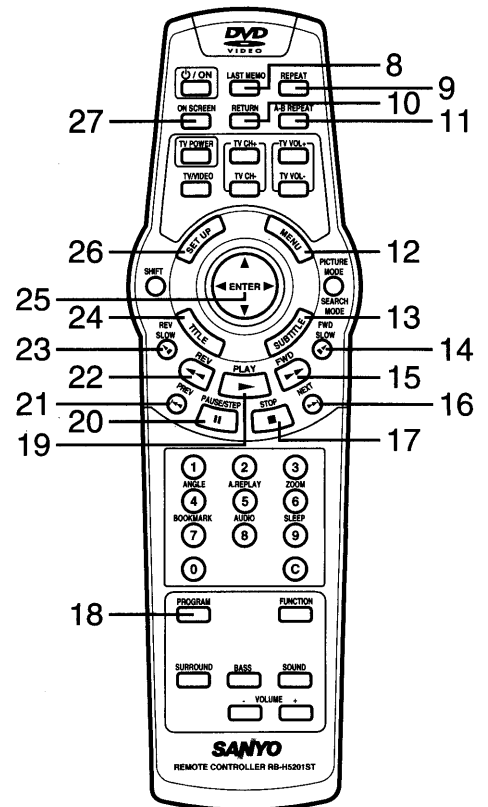
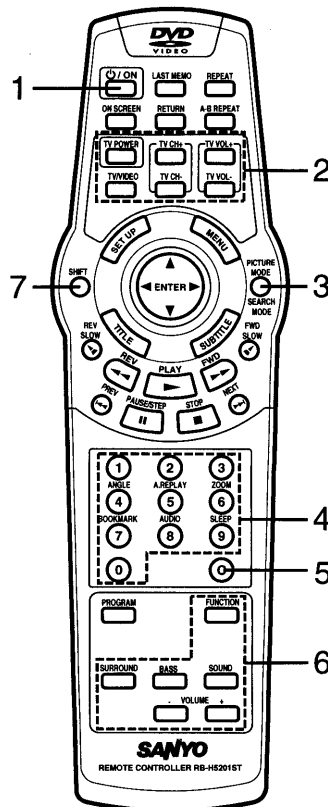

10. Return button (RETURN)
11. A-B repeat button (A-B REPEAT)
12. Menu button (MENU)
13. Subtitle button (SUBTITLE)
14. Forward slow button (FWD SLOW)
15. Forward button (FWD)
16. Skip/Next button (NEXT)
17. Stop button (STOP)
18. Programme button (PROGRAM)

19. Play button (PLAY)
20. Pause/Step button (PAUSE/STEP)
21. Skip/Previous button (PREV)
22. Reverse button (REV)
23. Reverse slow button (REV SLOW)
24. Title button (TITLE)
25. Joy-stick (ENTER, ▲, ►, ▼, ◀)
26. Setup button (SET UP)
27. On screen button (ON SCREEN)

**Inserting batteries**

Install two "R6 (HP 7)" batteries.

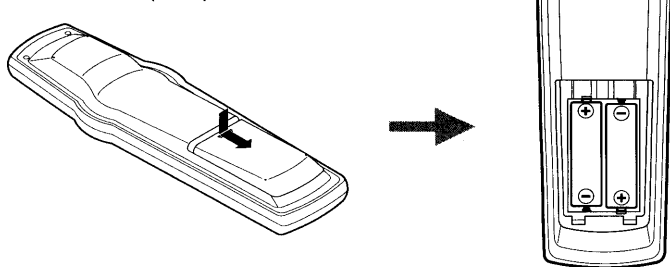

**Note:** Remove the batteries if the remote control is not to be used for a month or more. Batteries left in the unit may leak and cause damage.

**Remote control range**

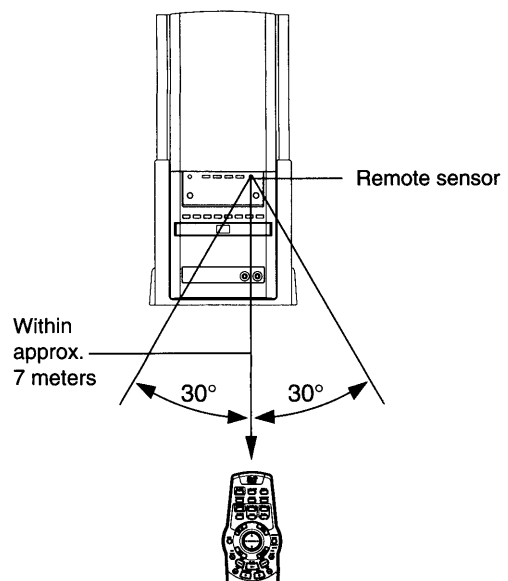

**Notes on using the joy-stick**

The joy-stick has five functions depending on the direction it is moved.

- Press straight down: ENTER
- Tilt towards the front: ▲
- Tilt towards the right: ►
- Tilt towards the back: ▼
- Tilt towards the left: ◀



Note: Control the stick using your thumb.

# BASIC CONNECTIONS

## Selecting TV system

Before connecting, be sure the TV SYSTEM switch (rear of the unit) setting corresponds with your local TV system (PAL or NTSC).

After all connections have been made, connect the mains lead to an AC outlet .

Note:

- Do not connect the mains lead to an AC outlet until all connections have been made.
- The system is not completely disconnected from the mains when the ⏻/ON button is set to the ⏻ position.

When the unit is first connected, the display switches automatically to the demonstration mode. To cancel this mode, turn the power on.

## Speaker placement and connections

### WARNING:

Do not place this product on an unstable place. The product may fall, causing serious injury, and serious damage to the product.

The supplied speaker has built-in magnetic stray field compensation. It may be placed close to a TV without affecting the colour purity. But, if an interference colour noise occurs on the TV screen, locate the speakers at least 30 cm from either side of the TV. To achieve proper stereo reproduction, connect the speaker wires without shorting to adjacent wires as shown below.

Example A:

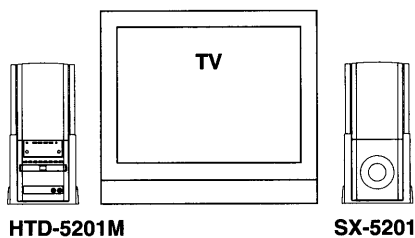

Example B:

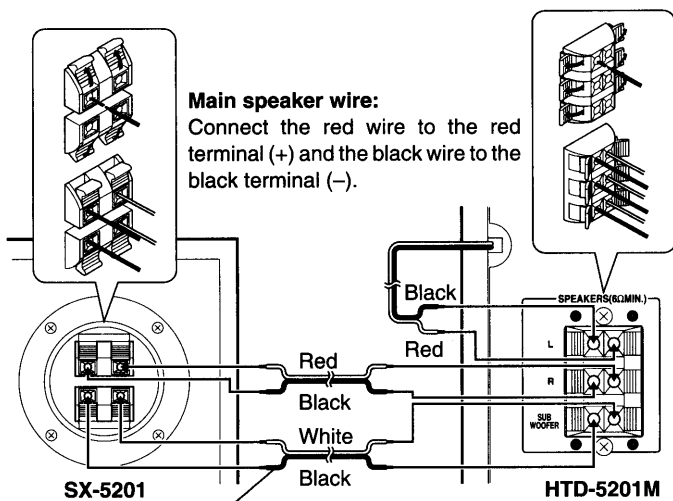
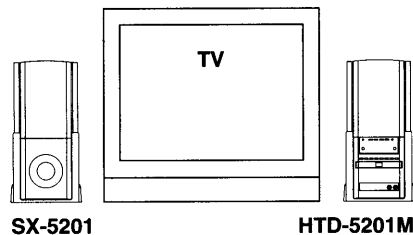

**Main speaker wire:**  
Connect the red wire to the red terminal (+) and the black wire to the black terminal (-).

**Subwoofer wire:**  
Connect the white wire to the red terminal (+) and the white terminal (+).  
Connect the black wire to the black terminal (-).

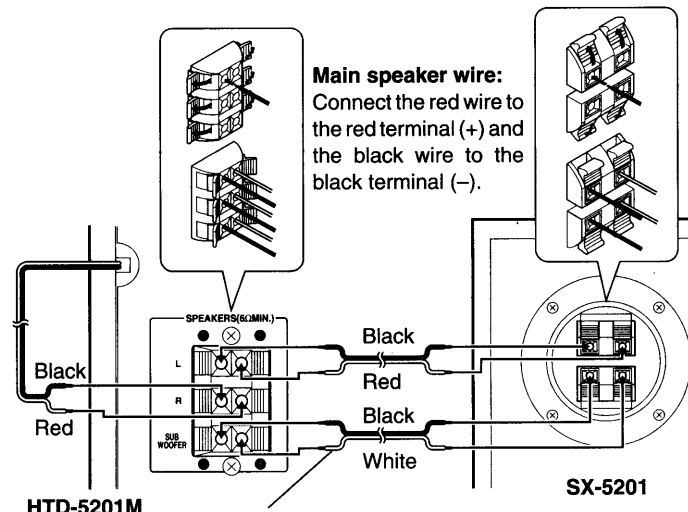

**Main speaker wire:**  
Connect the red wire to the red terminal (+) and the black wire to the black terminal (-).

**Subwoofer wire:**  
Connect the white wire to the red terminal (+) and the white terminal (+).  
Connect the black wire to the black terminal (-).

## Connecting to a TV with the video lead

Connect the MONITOR VIDEO OUT socket of the unit to the video input socket of the TV with the video lead.

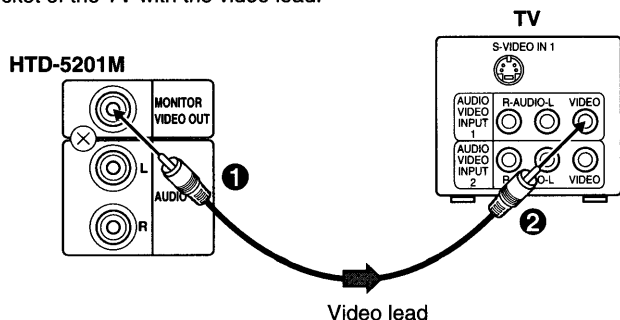

## Notes on connections

- Please refer to the instruction manuals for the components that you are connecting (TV, AV amplifier, etc.).
- When you connect the unit to your TV and other equipment, be sure to turn off the power and disconnect all of the equipments from the AC outlet until all the connections have been made.
- **Do not connect the unit to a VCR directly for DVD play. The playback picture will be distorted because DVD discs are copy protected.**
- Please consult your local audio/video dealer for more details.

# ADDITIONAL CONNECTIONS EXAMPLES

## Connecting to a TV with an S-video lead

1. If your TV has an S-video input socket, connect the unit as shown in figure. (The MONITOR VIDEO OUT socket connection is not necessary.) You can enjoy clearer picture playback.
2. Set the VIDEO OUT SELECT switch to S-VIDEO.

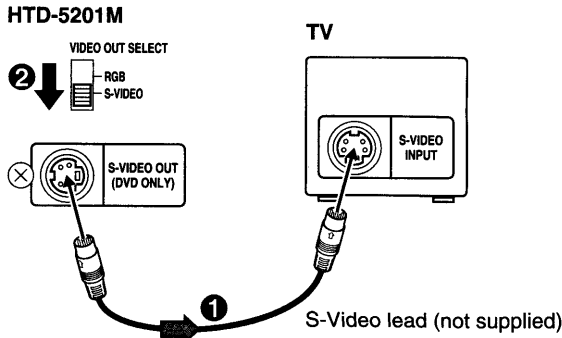

## Connecting to a TV with a EURO-AV cable

1. If your TV has a EURO-AV socket, connect the unit as shown in figure. (Do not connect the video lead to the MONITOR VIDEO OUT socket.) You can enjoy clearer picture playback.
2. Set the VIDEO OUT SELECT switch to RGB.

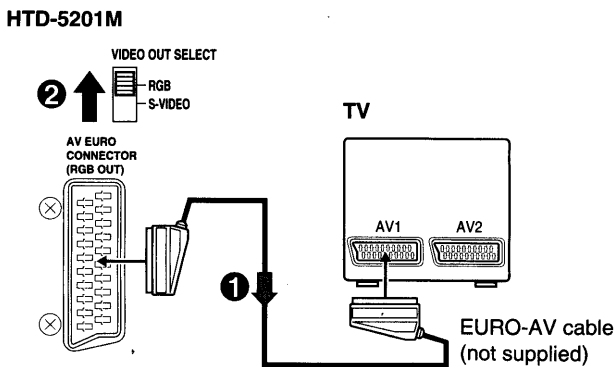

## Connecting to a digital multi-channel AV amplifier

The digital multi-channel sound of a DVD can best be decoded and played with a multi-channel AV amplifier (MPEG audio decoder or Dolby Digital decoder).

The AV amplifier has to be able to process the DTS audio signal in order to play a DVD with DTS. If it cannot, then you will not be able to hear the DVD.

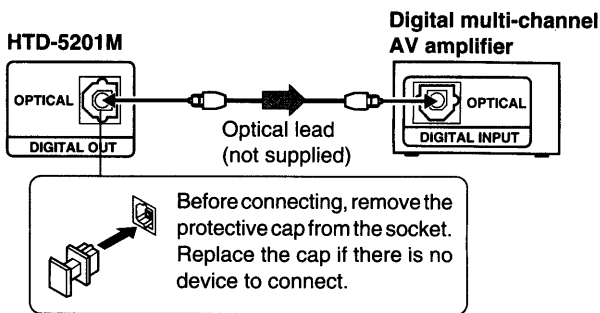

### Note:

- To enjoy Dolby Digital sound, select "Dolby Digital: 5.1ch" in "AUDIO" under "INITIAL SETTINGS". (See Page 13.)
- To enjoy MPEG sound, select "MPEG: MPEG" in "AUDIO" under "INITIAL SETTINGS".
- To enjoy DTS sound, select "DTS: ON" in "AUDIO" under "INITIAL SETTINGS".

Manufactured under license from Dolby Laboratories.

"Dolby" and the double-D symbol are trademarks of Dolby Laboratories.

"DTS" and "DTS Digital Out" are trademarks of Digital Theater Systems, Inc.

## VCR

If your TV has only one video input socket, connect the VCR as shown in figure.

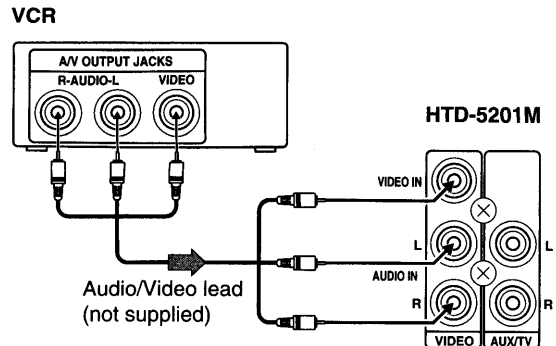

### Note:

- The picture from VCR may be distorted in some cases.
- When the VCR is connected to the unit, there are no VCR video signals from the S-VIDEO OUT socket of the unit and no VCR RGB video signals from the AV EURO CONNECTOR socket.

## Auxiliary equipment or TV

If you want to enjoy an auxiliary equipment or TV sound, connect it as shown in figure.

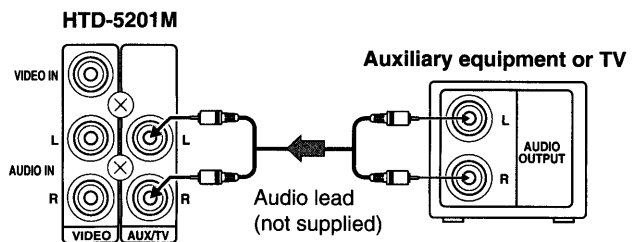

## Tape or MD deck

If you want to record the sound, connect a tape or MD deck as shown in figure.

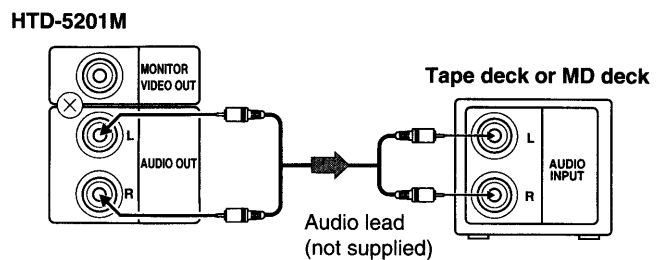

## Multimedia equipment

Connect an audio lead (not supplied) from the line output socket of the multimedia equipment (example: Personal computer, Electronic game, MD player, SSAP, etc.) to the MULTI MEDIA IN sockets.

## Headphones

Connect stereo headphones (not supplied) to the PHONES socket for monitoring or for private listening. The speakers are automatically disconnected when headphones are connected.

# BEFORE OPERATION

## Turning the power on and off

Press the  $\odot$ /ON button. "HELLO" briefly appears on the display and the STANDBY indicator goes out. (After connecting the mains lead, when you press the  $\odot$ /ON button for the first time, the volume-reset feature automatically sets the initial volume level.)

To turn the power off, press the  $\odot$ /ON button again. "GOOD-BYE" briefly appears and the STANDBY indicator lights.

- When the mains lead is connected to the AC outlet, the unit will respond to commands from the remote control.

## Direct start function

If the following buttons are pressed when the unit is in standby, the unit turns on automatically and the selected function is set.

Main unit      ► PLAY, ▲ OPEN/CLOSE  
Remote control    PLAY

## Selecting the function

Press the FUNCTION button to select the desired function. Each time the button is pressed, the display changes as follows:

DVD/CD → VIDEO → AUX/TV → M.MEDIA → DVD/CD → . . .

- When the function selection is changed, disc play is automatically stopped.

## Adjusting the volume

Press the + or - VOLUME button. The volume level appears on the display (VOL 0 ~ VOL MAX).

## Pure active surround system (PASS) (Remote control only)

This newly developed surround system gives natural spread-out atmosphere. Press the SURROUND button to select the desired surround effect.

PASS OFF → PASS HI → PASS MID → PASS LOW → PASS OFF

. . .

## Bass expander system (Remote control only)

Press the BASS button to select the desired bass expander effect.

BASS OFF → BASS LOW → BASS MID → BASS HI → BASS OFF

. . .

## Selecting the sound mode (Remote control only)

Press the SOUND button to select the sound mode matching the source to be listened to.

POP: Pops, etc.

CLASSIC: Classical music, etc.

JAZZ: Jazz, etc.

ACTION: Action, etc.

COMEDY: Comedy, etc.

SFX: Special effects, etc.

## Adjusting the display brightness (Main unit only)





While pressing the  $\mathbb{I}$ /STEP button, press the FUNCTION button.

DIMMER 1 → DIMMER 2 → DIMMER 0 (initial setting)

- In the DIMMER 2 mode, the display disappears in a few seconds.

# PLAYABLE DISCS

The following types of discs can be played on this unit.

Disc type and logo mark		Recorded content	Disc size	Maximum playing time
DVD Video		Audio + Video	12 cm	Approx. 4 hours (Single sided disc) Approx. 8 hours (Double sided disc)
			8 cm	Approx. 80 minutes (Single sided disc) Approx. 160 minutes (Double sided disc)
Video CD	 	Audio + Video	12 cm	74 minutes
			8 cm	20 minutes
Music CD		Audio	12 cm	74 minutes
			8 cm	20 minutes

## Region number

Region number (Regional restriction code) is built-in to the unit and DVD discs.

There is a region number on the rear of the unit.

The same region number or region number "ALL" of DVD discs can be used on this unit.

## DVD disc

There are the marks on some DVD disc package.

Examples:

 Multiple Languages

 Multi-language subtitles

 Multi-Angle

 Multi-Aspect

 Region number

DVD discs are divided into titles, and the titles are sub-divided into chapters.

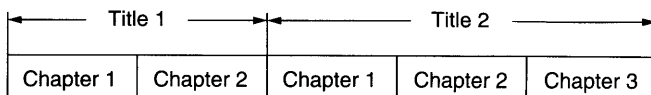

## Video CD/Music CD disc

Video CD and Music CD discs are divided into tracks.

Track 1	Track 2	Track 3	Track 4	Track 5
---------	---------	---------	---------	---------

Note:

- Only the above types of discs can be played on this unit. DVD-ROM, CD-ROM, SVCD, CVD, etc. cannot be played.
- CD-R can be played back, but it depends on the recorded condition.
- This unit is to be used exclusively with the PAL or NTSC colour system. SECAM system discs cannot be used with this unit.

## Notes on handling discs

- Do not expose the disc to direct sunlight, high humidity or high temperatures for extended periods of time.
- Discs should be returned to their cases after use.
- Do not apply paper or write anything on the disc surface.
- Handle the disc by its edge. Do not touch the playing surface (glossy side).
- Fingerprints and dust should be carefully wiped off the playing surface of the disc with a soft cloth.  
Wipe in a straight motion from the centre to the outside of the disc.
- Never use chemicals such as record cleaning sprays, antistatic sprays or fluids, benzene or thinner to clean discs.



# DISC PLAY

## Important note:

- This instruction manual explains the basic instruction of this unit using the remote control unit.
- Some DVD or Video CD discs have different functions that may not be explained in this instruction manual. You may be needed extra instructions. In this case, please follow the instructions displayed on the TV screen or jacket or case of the disc.
- "⊗" may appear on the TV screen during operation. This icon means that the function is not available on the disc now.

## Preparations

- Turn on the TV and select the channel for the DVD player.

### To use the remote control for TV

The remote control must be pointed toward your TV.

1. Press the TV POWER button to turn on the power.
2. Press the TV/VIDEO button to select the video input source.
3. Press the "—" TV VOL button to set the TV volume minimum, if necessary.

- Select the playback picture size according to the aspect ratio of the TV. (See "DISPLAY" under "INITIAL SETTINGS" on Page 12.)
- Turn on the AV amplifier, etc. and select the audio input for the DVD player.
- Select the desired language for the screen menus. (See "OSD" – "LANGUAGE" under "INITIAL SETTINGS" on Page 12.)

### Note:

- Do not touch the disc tray while it is moving.
- Never place anything except a disc on the disc tray. Foreign objects can damage the unit.
- Do not apply excessive force to the disc tray.
- One disc must be placed on the disc tray at a time.
- To open or close the disc tray, be sure to use the ▲ OPEN/CLOSE button (Main unit). Do not press the disc tray with your hand.

**When operation buttons are pressed, that operation is displayed on the TV screen for several seconds.**

If a disc is loaded, you can turn the unit on and begin play immediately by pressing the PLAY button.

1. Press the ▲ OPEN/CLOSE button. "OPEN" appears on the display and the disc tray opens. "SANYO" logo appears on the TV screen.
2. Place the disc with the label facing up on the disc tray.

12 cm disc

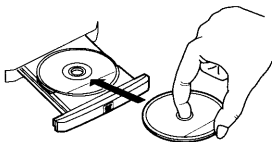

8 cm disc

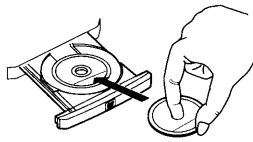

3. Press the ▲ OPEN/CLOSE button again to close the disc tray.
  - With some discs, play starts automatically.

## Starting play

Press the PLAY button. The DVD/CD function is selected and play starts automatically.

Example:

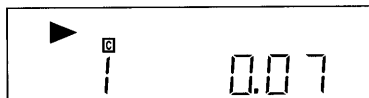

### Note:

If "NO DISC" appears on the display, load the disc.

- If the disc is loaded with the label side downward (and it is a single sided disc), or if a badly scratched disc is loaded, "NO DISC" (or "NO PLAY") appears. If this occurs, load the disc correctly or replace the disc.

## If a menu appears on the TV screen...

Press "▲", "▶", "▼" or "◀" on the joy-stick (or the number buttons), then press "ENTER" to select the desired item. Playback of the selected item will start.

Note:

For more details, please refer to the jacket or case of the disc.

## Stopping play

Press the STOP button. The player memories the point where you stopped.

When you press the PLAY button again, play starts automatically from the point where you stopped. (Resuming Playback)

Note:

Some discs may not start resuming playback.

**If the STOP button is pressed twice, the player stops completely. "STOP" appears on the display (DVD only).**

## Continuing play from where you stopped watching (LAST MEMO PLAY)

1. During play, press the LAST MEMO button at the point from which you want to resume play later. "L.M." appears on the display. Play stops automatically.
2. Remove the disc or turn off the power.
3. Load the disc (and press the PLAY button), or turn on the power. Play resumes from the point where you stopped. (The memory is released.)

Note:

- Points on up to 5 discs can be memorized.
- The Last Memo Play mode may not work correctly with some discs.

## What is "PBC"?

"PBC" is an abbreviation for "Playback Control" that refers to control codes prerecorded on Video CDs.

During playback of Video CD with PBC, "PBC" appears on the display.

# VARIOUS DISC PLAYING FUNCTIONS

"⊘" may appear on the TV screen during operation. This icon means that the function is not available on the disc now.

## Chapter (Track) skip

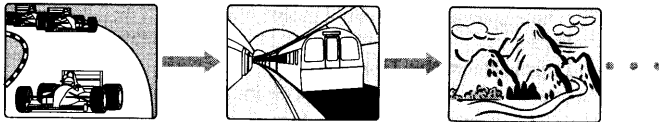

### Skipping forward

Press the NEXT (or ►►) on the main unit) button during play to skip to the next chapter (or track). A chapter (or track) is skipped each time the button is pressed.

### Skipping back

Press the PREV (or ◀◀) on the main unit) button during play to skip back to the beginning of the chapter (or track) currently play. Press the button again immediately to skip back to the beginning of the previous chapter (or track).

## Title/Chapter (Track) search

1. Press the SHIFT + SEARCH MODE buttons once during play or in the stop mode. "TITLE/CHAPTER SEARCH" or "TRACK SEARCH" screen appears.
2. Press the number buttons to enter the title (or track) number.
3. Press the joy-stick (▼).
4. Press the number buttons to enter the chapter number. (For Video CD and Music CD, skip the step of 3 and 4.)  
Note:
  - If you made a mistake, press the C button.
  - To quit this menu, press the SHIFT + SEARCH MODE buttons twice.
5. Press the ENTER button. The selected title and chapter (or track) play starts.

## Time search

1. Press the SHIFT + SEARCH MODE buttons twice during play. "TIME SEARCH" screen appears.
2. Press the number buttons to enter the time.  
Example:  
20 minutes 5 seconds      Press 2, 0, 0 and 5.  
1 hour 4 minutes 35 seconds      Press 1, 0, 4, 3 and 5.  
Note:
  - If you made a mistake, press the C button.
  - To quit this menu, press the SHIFT + SEARCH MODE buttons.
3. Press the ENTER button. Play starts from the searched time.

## Fast play

Press the FWD or REV button repeatedly to select the fast speed forward or reverse play.

### [DVD] [Video CD]

"FF1 ►►", "FF2 ►►", "FF3 ►►" or "FR1 ◀◀", "FR2 ◀◀", "FR3 ◀◀"

### [CD]

"FF1 ►►", "FF2 ►►" or "FR1 ◀◀", "FR2 ◀◀"

Press the PLAY button to return to normal play.

## Slow-motion play

[DVD] [Video CD]: Forward slow play, [DVD]: Reverse slow play  
Press the FWD SLOW or REV SLOW button repeatedly to select the forward or reverse slow speed play.

"SF1 ►", "SF2 ►", "SF3 ►" or "SR1 ◀", "SR2 ◀", "SR3 ◀"

Press the PLAY button to return to normal play.

### Note: [DVD] [Video CD]

The sound is muted during fast play or slow-motion play.

## Still picture (Pause)

[DVD] [Video CD]: Still picture mode, [CD]: Pause mode

Press the PAUSE/STEP button during play. Press the PLAY button to return to normal play.

Note: The sound is muted.

## Frame by frame advance play [DVD] [Video CD]

Press the PAUSE/STEP button during still play. Each time the button is pressed, the picture advances one frame.

Press the PLAY button to return to normal play.

Note:

- The sound is muted.
- Frame play is operated forward only.

## Zoom feature [DVD]

1. Press the SHIFT + ZOOM buttons during normal play or still play. The player magnifies the image (2 times) in the centre of the picture.

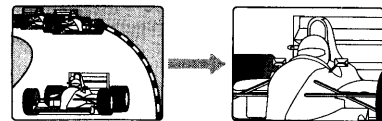

2. Press the joy-stick (▲, ►, ▼ or ◀) to change the zoom point.
3. To return to normal play or still play, press the SHIFT + ZOOM buttons again.

Note:

Some discs may not work Zoom feature.

## Viewing from a desired camera angle (Multi-Angle) [DVD]

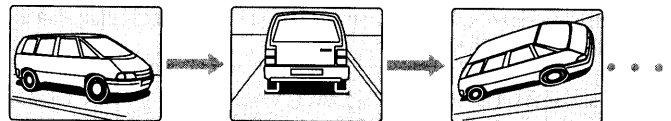

Some DVD discs may contain scenes which have been shot simultaneously from a number of different camera angles. The jacket or case of discs that are recorded with angles will be marked.

Example:



Note: The recorded angles differ depending on the disc used.

1. Play the disc that is recorded with angles.
2. Press the SHIFT + ANGLE buttons repeatedly until the desired angle appears.

Example:

Angle  
03

## Angle replay [DVD]

During Multi-angle play screen, press the SHIFT + A.REPLAY buttons. The player skips back to last approximately 10 seconds, changes it to the next camera angle and plays it, and continues play. (If desired, press the buttons again.)

## Repeat play

Press the REPEAT button during play (or programmed play) of the title or chapter (or track) you want to repeat. Each time the button is pressed, the repeat mode changes as follows.

### [DVD]

All Repeat/(REP. ALL): Repeat all titles

Title Repeat/(REP. 1): Repeat of title being played

Chapter Repeat/(REP. 1): Repeat of chapter being played

Program Repeat/(PROG. REP.): Repeat programmed play

Clear: Normal play mode

### [Video CD] [CD]

All Repeat/(REP. ALL): Repeat all tracks

Repeat 1/(REP. 1): Repeat of track being played

Program Repeat/(PROG. REP.): Repeat programmed play

Clear: Normal play mode

## Designated range repeat play (A-B Repeat)

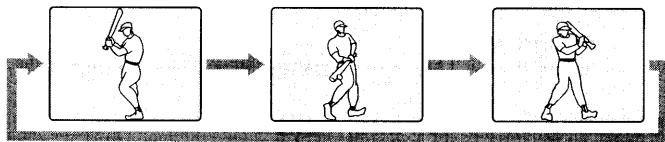

1. Press the A-B REPEAT button during play at the beginning of the section you want to repeat (Point A). "Repeat A-" appears on the screen. "REP. A-B" blinks on the display.
  2. Press the A-B REPEAT button at the end of the section (Point B). "REP. A-B" remains lit on the display. The section between points A and B is played repeatedly.
- Note:  
For Video CD, wait 2 seconds at least before pressing the button.
3. Press the A-B REPEAT button again to return to normal play.

Note:

Normal repeat play or A-B repeat play mode may not work correctly with some discs.

## Return button (RETURN) for Video CD

Normally, it returns to the previous menu during play when the RETURN button is pressed.

Note:

The operation differs according to the content of the Video CD.

## Programmed play

Up to 32 selections can be programmed.

### Programming procedure

1. Press the PROGRAM button during play or stop mode. "PROGRAM" screen appears. "PROG." blinks on the display.
2. Press the joy-stick (▲, ►, ▼ or ◀) to select the title, chapter or track.

Example:

PROGRAM		
ALL CLEAR	TITLE	CHAPTER
No. : T, C		
1 : 2, 5	-	All
2 : -, -	1	1
3 : -, -	2	2
4 : -, -	3	3
5 : -, -	4	4
6 : -, -		5
7 : -, -		6
8 : -, -		
9 : -, -		
10 : -, -		

Programme number

3. Press the ENTER button. The highlighted box automatically moves to the next programme number.
  4. Repeat steps 2 - 3 above to select another title, chapter or track.
- Note:  
If you want to quit this menu, press the PROGRAM button.
5. Press the PLAY button to start play. "PROG." remains lit.

Note:

If you wish to play the programme again, press the PROGRAM button to call up the programme screen then press the PLAY button.

### To clear the programme one by one

In the programming mode, press the joy-stick (▲, ►, ▼ or ◀) to select the programme number. Then press the C button.

### To clear all the programmes

In the programming mode, press the joy-stick (▲, ►, ▼ or ◀) to select "ALL CLEAR". Then press the ENTER button.

## Setting and playing bookmarks

Up to five bookmarks can be memorized for the last five discs played, then select them directly for playback.

Note: Some discs may not work bookmark function.

### Setting or clearing bookmarks

1. Press the SHIFT + BOOKMARK buttons during play. "BOOKMARK" screen appears.

Example:

#### BOOKMARK

No :	T, C
1 :	NONE
2 :	NONE
3 :	NONE
4 :	NONE
5 :	NONE

2. Press the joy-stick (▲ or ▼) to select the bookmark number.
3. Press the ENTER button at the starting point to be viewed (listened to) again.

Example:

#### BOOKMARK

No :	T, C
1 :	ENTRY 1, 6
2 :	NONE
3 :	NONE
4 :	NONE
5 :	NONE

Note:

- If you made a mistake, press the C button.
- To quit this menu, press the SHIFT + BOOKMARK buttons.

### Recalling a bookmark

1. Press the SHIFT + BOOKMARK buttons.
2. Press the joy-stick (▲ or ▼) to select the bookmark number to be recalled.
3. Press the PLAY button. Play resumes from the point corresponding to the selected bookmark.

### Clearing a bookmark

1. Press the SHIFT + BOOKMARK buttons.
2. Press the joy-stick (▲ or ▼) to select the bookmark number to be cleared, then press the C button.

## Selecting a title menu [DVD]

1. Press the TITLE button. The title menu appears.

Note:

Press the TITLE button again to resume play from the scene when the TITLE button was first pressed.

2. Press the joy-stick (▲, ►, ▼ or ◀) (or the number buttons) to select the desired title, then press the ENTER button. The selected title play starts.

## Selecting a DVD menu [DVD]

1. Press the MENU button. The main menu screen appears.

Note:

Press the MENU button again to resume play.

2. Press the joy-stick (▲, ►, ▼ or ◀) (or the number buttons) to select the desired menu.
3. Press the ENTER button. The selected menu play starts.

Note:

- The selecting a title or DVD menu operation may differ depending on the disc used.
- Selecting a title menu or DVD menu may not be possible on some discs.

## Selecting subtitle language [DVD]

This operation works only with discs on which multiple subtitle languages are recorded.

1. Press the SUBTITLE button during play. "SUBTITLE MODE" screen appears.

Example:

	SUBTITLE MODE
ON	ENG
OFF	

2. Press the joy-stick (▲, ►, ▼ or ◀) to select the desired subtitle language then press the ENTER button.

Note:

- In some cases, the subtitle language is not changed to the selected one.
- When a disc supporting the closed caption is played, the subtitle and the closed caption may overlap each other on the TV screen. In this case, turn the subtitle off.
- When the desired language is not selected even if the button is pressed, the language is not available on the disc.
- When the power is turned on, the function is changed, the player is stopped completely or the disc is replaced, select the subtitle language again.
- If the subtitle language is not necessary, select "OFF".

## Selecting audio soundtrack language (Multi-Language) [DVD]

This operation works only with discs on which multiple audio soundtrack languages are recorded.



1. Press the SHIFT + AUDIO buttons during play.
2. Press the SHIFT + AUDIO buttons repeatedly until the desired language appears on the screen.

Example: Language Change  
02 GER

Note:

- When the desired language is not selected even if the button is pressed, the language is not available on the disc.
- When the power is turned on, the function is changed, the player is stopped completely or the disc is replaced, select the language again.
- If the language is not recorded on the disc, only the available language on the disc will be heard.

## Changing the audio channel output [Video CD] [CD]

During Video CD/CD play, press the SHIFT + AUDIO buttons to select an audio channel.

LEFT MONO → RIGHT MONO → STEREO → LEFT MONO...

Note: You cannot change an audio channel with the optical DIGITAL OUT socket.

## Selecting picture mode

Press the PICTURE MODE button. Each time the button is pressed, the picture mode is changed as shown:

PICTURE MODE  
Standard → Mild → Black and White → Standard ...

## Selecting on-screen information

Press the ON SCREEN button repeatedly to show the disc information (Title, Chapter, Title pass time, Language, etc.).

Example for DVD:

DVD		Play ▶
TITLE: 01	Title pass time	00:05:45
CHAPTER: 04	Chapter pass time	00:00:51

AUDIO: ENG
Dolby Digital 2ch
SUBTITLE: ENG
ANGLE: 1



DVD		Play ▶
TITLE: 01	Title remain time	00:56:07
CHAPTER: 04	Chapter remain time	00:00:37

AUDIO: ENG
Dolby Digital 2ch
SUBTITLE: ENG
ANGLE: 1

# INITIAL SETTINGS

Once the initial settings have been completed, the player can always be operated under the same conditions. The settings will be retained in the memory until they are changed, even if the power is turned off.

## Common procedures of initial settings

1. Press the SET UP button in the stop mode. "SET UP MENU" appears on the TV screen.
2. Press the joy-stick (▲, ►, ▼ or ◀), then press the ENTER button to select the menu. Please refer to the on-screen instructions.
3. Press the SET UP button to quit this menu.

Example:



	OSD:	ENG	ENG GER FRE ITA SPA POR DAN SWE FIN	SUBTITLE:	DISC	DISC ENG GER FRE ITA SPA POR DAN SWE FIN Others
	AUDIO:	DISC	DISC ENG GER FRE ITA SPA POR DAN SWE FIN Others	DVD MENU:	DISC	DISC ENG GER FRE ITA SPA POR DAN SWE FIN Others

(DISC: It will use its first priority language setting.)

Note:

- You cannot switch audio sound track languages if there is only one language recorded on the disc.
- When you play a DVD disc, the player automatically displays the pre-selected subtitle language if it is included.
- If "Others" is selected, enter the language code. (See "LANGUAGE CODE LIST".)

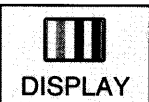
**For improvement, on screen displays subject to change without notice.**

	TV TYPE:	4:3 LT	4:3 LT 4:3 PS 16:9	<b>16:9 :</b> Select when a wide screen TV set is connected. Played in "FULL" size. (Setting the wide screen TV to "FULL" mode is also necessary.)	
	SCREEN SAVER:	ON	ON OFF	Note:	
	LastMemo Play:	ON	ON OFF	- The screen size may differ depending on the DVD discs. - If you select 16:9 to get rid of the black bands on screen when wide screen disc is played back, picture may be slightly distorted. - In some discs, even if 4.3 PS is selected, the black bands will remain on the screen.	

Select the appropriate your TV screen size.

### 4:3 LT (Letterbox):

Select when a conventional TV set is connected. When the wide screen disc is played back, the black bands appear at the top and bottom of screen.



### 4:3 PS (Panscan):

Select when a conventional TV set is connected. When the wide screen disc is played back, it displays pictures cropped to fill your TV screen. The left and right edges are cut off.

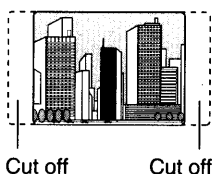

If the Last Memo Play is not necessary, set LastMemo Play to "OFF".



DIGITAL OUT:	ON	ON	(Note: It is "ON" only.)
Dolby Digital:	2ch	5.1ch 2ch	Select PCM "2ch" or Dolby Digital "5.1ch".
MPEG:	PCM	MPEG PCM	Select PCM or MPEG signal.
DTS:	OFF	ON OFF	Select DTS signal "ON" or "OFF". Note: When using a Digital Amplifier without a DTS decoder, set DTS to "OFF".



Enter password.  
Enter a number in 4 digits, then press ENTER.

(To confirm, enter password again, then press ENTER.)

Invalid password.  
Enter password again.

LEVEL:	8	8
		7
		6
		5
		4
		3
		2
		1
		OFF

STANDARD: USA USA

**CHANGE PASSWORD**

Change password.  
Enter a number in 4 digits, then press ENTER.

To confirm, enter password again, then press ENTER.

**Parental control**

MPAA (Motion Picture Association of America) Guideline is rating system that provide advance cautionary information to parent about the content of movie programmes.

The parental lock level is equivalent to the following MPAA Rating System.

Level 7: NC-17 (No one 17 and under admitted)

Level 6: R (Restricted)

Level 4: PG13 (Parental guidance cautioned)

Level 3: PG (Parental guidance suggested)

Level 1: G (General audiences)

Some DVD discs contain a restriction level which enables parents to prevent playback of discs by children. This DVD player is equipped with a password designed to prevent children changing the level.

You cannot play DVD discs rated higher than the level you selected unless you cancel the parental lock function.

For example, when you select level "5", the player will not play discs with ratings of "6", "7" or "8". The information will appear on the TV screen.

**If you forget the password...**

Enter "788444" to clear the current password.

Enter a new password and set the parental lock level again.

**Note:**

DVD discs may or may not respond to the parental lock settings. Make sure this function works with your DVD discs.

**To lock the disc tray**

You can lock the disc tray to prevent misuse of young children.

Enter password "123456" to set the disc tray lock mode.

- The ▲ OPEN/CLOSE button will not function.

To release this mode, enter the same password again.

# LANGUAGE CODE LIST

Enter the appropriate code number for the initial settings "AUDIO", "SUBTITLE" and "DVD MENU".

Code	Language	Code	Language	Code	Language
6565	Afar	7369	Interlingue	8278	Kirundi
6566	Abkhazian	7375	Inupiak	8279	Romanian
6570	Afrikaans	7378	Indonesian	8285	Russian
6577	Amharic	7383	Icelandic	8287	Kinyarwanda
6582	Arabic	7384	Italian	8365	Sanskrit
6583	Assamese	7387	Hebrew	8368	Sindhi
6589	Aymara	7465	Japanese	8371	Sangro
6590	Azerbaijani	7473	Yiddish	8372	Serbo-Croatian
6665	Bashkir	7487	Javanese	8373	Singhalese
6669	Byelorussian	7565	Georgian	8375	Slovak
6671	Bulgarian	7575	Kazakh	8376	Slovenian
6672	Bihari	7576	Greenlandic	8377	Samoan
6673	Bislama	7577	Cambodian	8378	Shona
6678	Bengali; Bangla	7578	Kannada	8379	Somali
6679	Tibetan	7579	Korean	8381	Albanian
6682	Breton	7583	Kashmiri	8382	Serbian
6765	Catalan	7585	Kurdish	8383	Siswati
6779	Corsican	7589	Kirghiz	8384	Sesotho
6783	Czech	7665	Latin	8385	Sundanese
6789	Welsh	7678	Lingala	8386	Swedish
6865	Danish	7679	Laothian	8387	Swahili
6869	German	7684	Lithuanian	8465	Tamil
6890	Bhutani	7686	Latvian, Lettish	8469	Tegulu
6976	Greek	7771	Malagasy	8471	Tajik
6978	English	7773	Maori	8472	Thai
6979	Esperanto	7775	Macedonian	8473	Tigrinya
6983	Spanish	7776	Malayalam	8475	Turkmen
6984	Estonian	7778	Mongolian	8476	Tagalog
6985	Basque	7779	Moldavian	8478	Setswana
7065	Persian	7782	Marathi	8479	Tonga
7073	Finnish	7783	Malay	8482	Turkish
7074	Fiji	7784	Maltese	8483	Tsonga
7079	Faeroese	7789	Burmese	8484	Tatar
7082	French	7865	Nauru	8487	Twi
7089	Frisian	7869	Nepali	8575	Ukrainian
7165	Irish	7876	Dutch	8582	Urdu
7168	Scots Gaelic	7879	Norwegian	8590	Uzbek
7176	Galician	7967	Occitan	8673	Vietnamese
7178	Guarani	7977	(Afan) Oromo	8679	Volapük
7185	Gujarati	7982	Oriya	8779	Wolof
7265	Hausa	8065	Punjabi	8872	Xhosa
7273	Hindi	8076	Polish	8979	Yoruba
7282	Croatian	8083	Pashto, Pushto	9072	Chinese
7285	Hungarian	8084	Portuguese	9085	Zulu
7289	Armenian	8185	Quechua		
7365	Interlingua	8277	Rhaeto-Romance		

## ENJOYING OTHER SOURCES

### VCR

1. Press the FUNCTION button to select "VIDEO".
2. Follow the instructions supplied with the VCR.

Note: The picture may be distorted in some cases.

### AUX/TV

1. Press the FUNCTION button to select "AUX/TV".
2. Follow the instructions supplied with the auxiliary equipment or TV.

### Multi media

1. Press the FUNCTION button to select "M.MEDIA".
2. Follow the instructions supplied with the multimedia equipment.

## SLEEP TIMER

The sleep timer automatically switches off the power after a preset time has elapsed. The volume will gradually be reduced (fade-out) during the 1-minute period before the unit turns off. There are 12 time periods available: 120, 110, 100, 90, 80, 70, 60, 50, 40, 30, 20, and 10 minutes.

Press the SHIFT + SLEEP buttons repeatedly to select the desired sleep time.

"SLEEP" appears and the selected time blinks on the display. After several seconds, blinking stops and the brightness of the display reduces.

### To release the sleep timer while in operation

1. Press the SHIFT + SLEEP buttons at least 2 seconds.
2. Press the SHIFT + SLEEP buttons repeatedly until "SLEEP" disappears.

## MAINTENANCE

### Cleaning the unit

Clean the outside of the unit with a clean soft cloth moistened with lukewarm water. Do not use benzene, thinner or alcohol since they will mar the finish of the surfaces.



# TROUBLESHOOTING GUIDE

If you have followed the instructions and are having difficulty operation the unit, locate the SYMPTOM in the left column below. Check the corresponding POSSIBLE CAUSE and CORRECTIVE ACTION columns to locate and remedy the problem.

SYMPTOM	POSSIBLE CAUSE	CORRECTIVE ACTION
No picture.	The wrong function is selected.	Select the correct function.
	No disc is loaded or an unplayable disc is loaded.	Load a disc or load a playable disc. (Check the disc logo, type, colour system and regional code.)
	The TV is not set to receive signal from the unit.	Select the correct input function on the TV.
No sound.	The wrong function is selected.	Select the correct function.
	Volume control is set to minimum.	Turn up the volume.
The playback picture is poor.	An unplayable disc is loaded.	Load a playable disc. (Check the disc logo, type, colour system and regional code.)
"⊗" appears on the TV screen.	The selected function does not operate on the disc now.	The feature or action cannot be completed at this time because: <ul style="list-style-type: none"> <li>- The feature is not available at the moment.</li> <li>- The DVD software restricts it.</li> <li>- The DVD software does not support the feature (e.g., angles).</li> </ul>
The player does not start play.	No disc is loaded.	Load a disc.
	An unplayable disc is loaded.	Load a playable disc. (Check the disc logo, type, colour system and regional code.)
	The disc is loaded with the label side down.	Load the disc on the disc tray correctly.
	The disc is dirty.	Clean the disc or replace it.
	"PARENTAL" is set.	Cancel the parental lock function or change the rating level. Reset it after play.
The operation or display is not normal.	The memory must be reset.	<ol style="list-style-type: none"> <li>1. Disconnect the mains lead.</li> <li>2. Reconnect the mains lead.</li> <li>3. Resume operation.</li> </ol>
The remote control does not work properly.	The batteries in the remote control are weak, or installed incorrectly.	Check the battery polarity (+ or -). Replace the batteries.
	The remote control is not aimed at the remote sensor window.	Aim the remote control at the remote sensor window.

# SPECIFICATIONS

## HTD-5201M: Main unit with main speaker

### General

#### Output power:

Total power  
90 W

Main amplifier  
30 W x 2 (at 6 ohms, 10% distortion)

Subwoofer amplifier  
30 W (at 6 ohms, 10% distortion)

#### Inputs

##### VIDEO:

VIDEO IN: 1.0 Vp-p (75 ohms)

AUDIO IN: 600 mV/50k ohms

AUX/TV: 600 mV/50k ohms

#### Outputs

##### SPEAKERS:

6 ohms/Main, 6 ohms/Subwoofer

##### PHONES:

8 - 32 ohms

##### DIGITAL OUT:

Optical

##### AV EURO CONNECTOR:

For Euro-AV cable

##### MONITOR VIDEO OUT:

1.0 Vp-p (75 ohms)

##### AUDIO OUT:

600 mV (1 kohm)

##### S-VIDEO OUT:

Y: 1.0 Vp-p (75 ohms) NTSC, 1.0 Vp-p (75 ohms) PAL

C: 0.286 Vp-p (75 ohms) NTSC, 0.3 Vp-p (75 ohms) PAL

#### Power requirements:

AC 230 V, 50 Hz

#### Power consumption:

100 W

1.4 W (standby mode)

#### Dimensions:

200(W) x 400(H) x 320(D) mm

#### Weight:

8.7 kg

## DVD/CD player

#### Type:

DVD/CD player

#### Playback standard:

PAL or NTSC

#### Laser:

Semiconductor laser, wavelength: 650 nm

Laser output (Continuous wave max.):

1 mW (DVD)

0.5 mW (CD)

#### Frequency range (digital audio):

4 Hz to 44 kHz (DVD fs: 96 kHz)

#### Signal to noise ratio:

More than 105 dB

#### Harmonic distortion (digital audio):

0.003 %

#### Wow and flutter:

Below measurable level

## Main speaker (magnetic shield)

#### Unit used:

10 cm cone type

#### Maximum power-handling capacity:

60 W (peak)

#### Nominal impedance:

6 ohms

## SX-5201: Main speaker with subwoofer

## Main speaker (magnetic shield)

#### Unit used:

10 cm cone type

#### Maximum power-handling capacity:

60 W (peak)

#### Nominal impedance:

6 ohms

## Subwoofer (magnetic shield)

#### Unit used:

13 cm cone type

#### Maximum power-handling capacity:

60 W (peak)

#### Nominal impedance:

6 ohms

## General

#### Dimensions:

200(W) x 400(H) x 320(D) mm

#### Weight:

5.8 kg

Specifications subject to change without notice.

## IMPORTANT INFORMATION

Because its products are subject to continuous improvement, SANYO reserves the right to modify product designs and specifications without notice and without incurring any obligation.



## **GUARANTEE TO CUSTOMER**

Sanyo Europe Ltd. (the Company) guarantees to the initial retail purchaser that if this equipment is or becomes defective and that, in the opinion of the Company, the defect is due to faulty material or workmanship the Company will, for a period of 12 calendar months from the date of sale to the original purchaser repair or replace, at its sole option, free of charge, any such defective component part of the equipment, always provided that: -

1. The equipment has at all times been used in accordance with the operating instructions issued by the Company, and has not been connected to an electrical mains supply for which it has not been adjusted.
2. Accidental damage, or damage caused by negligence or misuse by the user, including leakage from exhausted batteries, is specifically excluded.
3. Unauthorised repairs, or any modification to the equipment which has not been expressly approved by the Company, shall render this guarantee null and void.
4. Failure due to fair wear and tear of any item, such as batteries, record playing styli, and tape recording, playback and erase heads is specifically excluded.

This guarantee is not transferable and is only applicable within the United Kingdom (and the Republic of Ireland). Nothing in this express guarantee affects the statutory rights available to the purchaser of this equipment.

Note: This guarantee supersedes any other form of guarantee that may inadvertently have been enclosed with or attached to the product. (August 1978).

*Dear Customer*

Thank you for buying Sanyo. This equipment should give you many years of pleasure and faithful service but in the event that a fault occurs, the following notes for your guidance may be helpful:-

1. PLEASE RETAIN YOUR PURCHASE RECEIPT WHICH WILL BE REQUIRED FOR SERVICE DURING GUARANTEE.
2. If your Sanyo equipment proves faulty during the period of guarantee, take it or send it back to the dealer who originally supplied it together with this guarantee and the proof of purchase. We have made arrangements with our approved dealers under which they will carry out in-guarantee service repairs on our behalf. In this way, we hope to reduce to a minimum the amount of time you will be without your equipment.
3. If for some reason it is impossible to return the equipment to the original supplies, please contact our Consumer Relations Department at the address below for further advice.
4. Should the equipment require servicing after the expiry of the guarantee period, take or send it to the original supplier or any other Sanyo dealer. He will be pleased to give you a quotation for the repair. If you are in any doubt about what to do, write to us at the address below or telephone:

**Consumer Relations Department,  
Sanyo Europe Ltd.,  
Sanyo House  
Otterspool Way, Watford,  
Hertfordshire WD2 8JX  
Tel: Watford 246363**

R5

The Sanyo logo consists of the word "SANYO" in a bold, sans-serif font. The letter "Y" is stylized with multiple vertical lines passing through it, creating a sense of motion or depth.

SANYO Electric Co., Ltd.